

TR160 Platter Dimensions

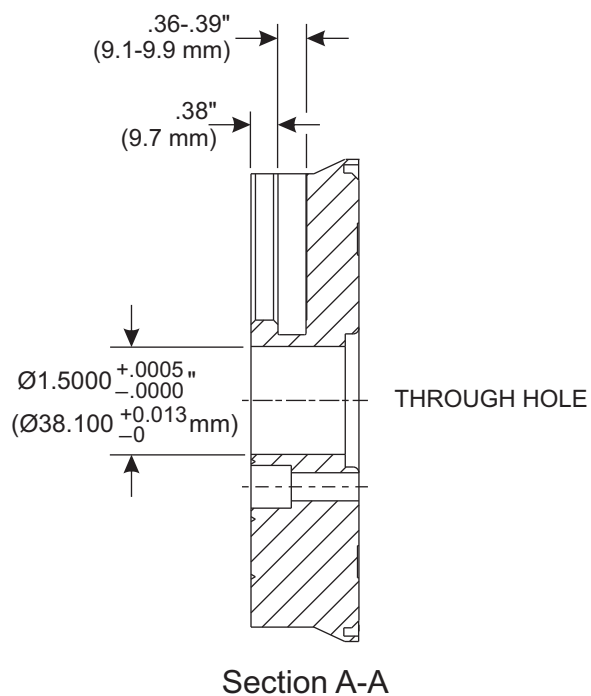
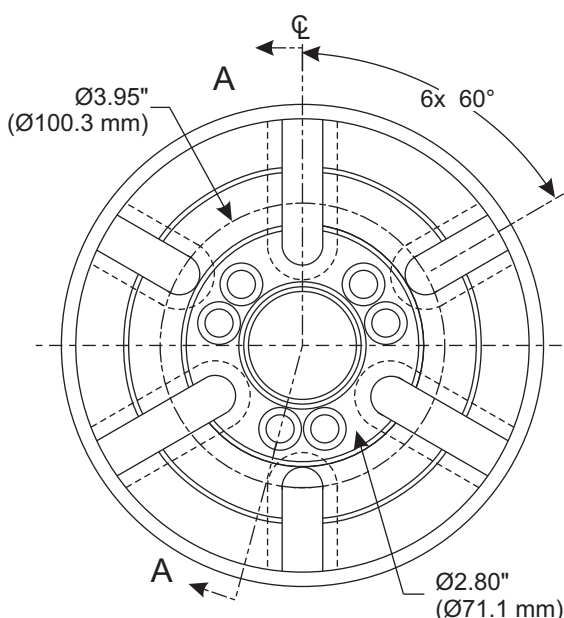
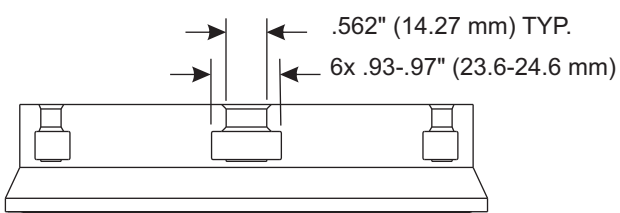

For mounting instructions, see Rotary Operator's Manual.

Go to [www.haascnc.com](http://www.haascnc.com) for further rotary specifications.