

HA5C3 Machine Layout Drawing

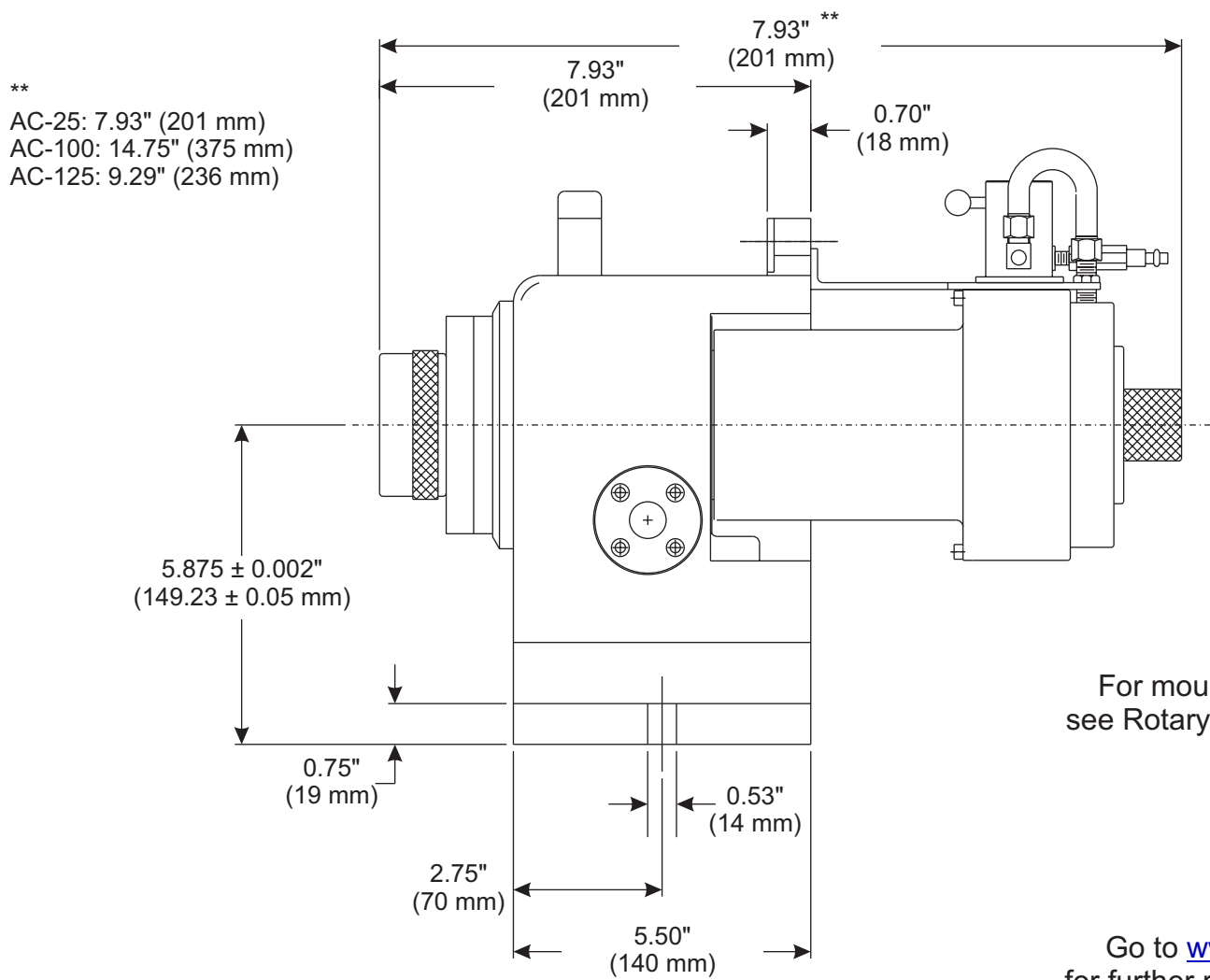
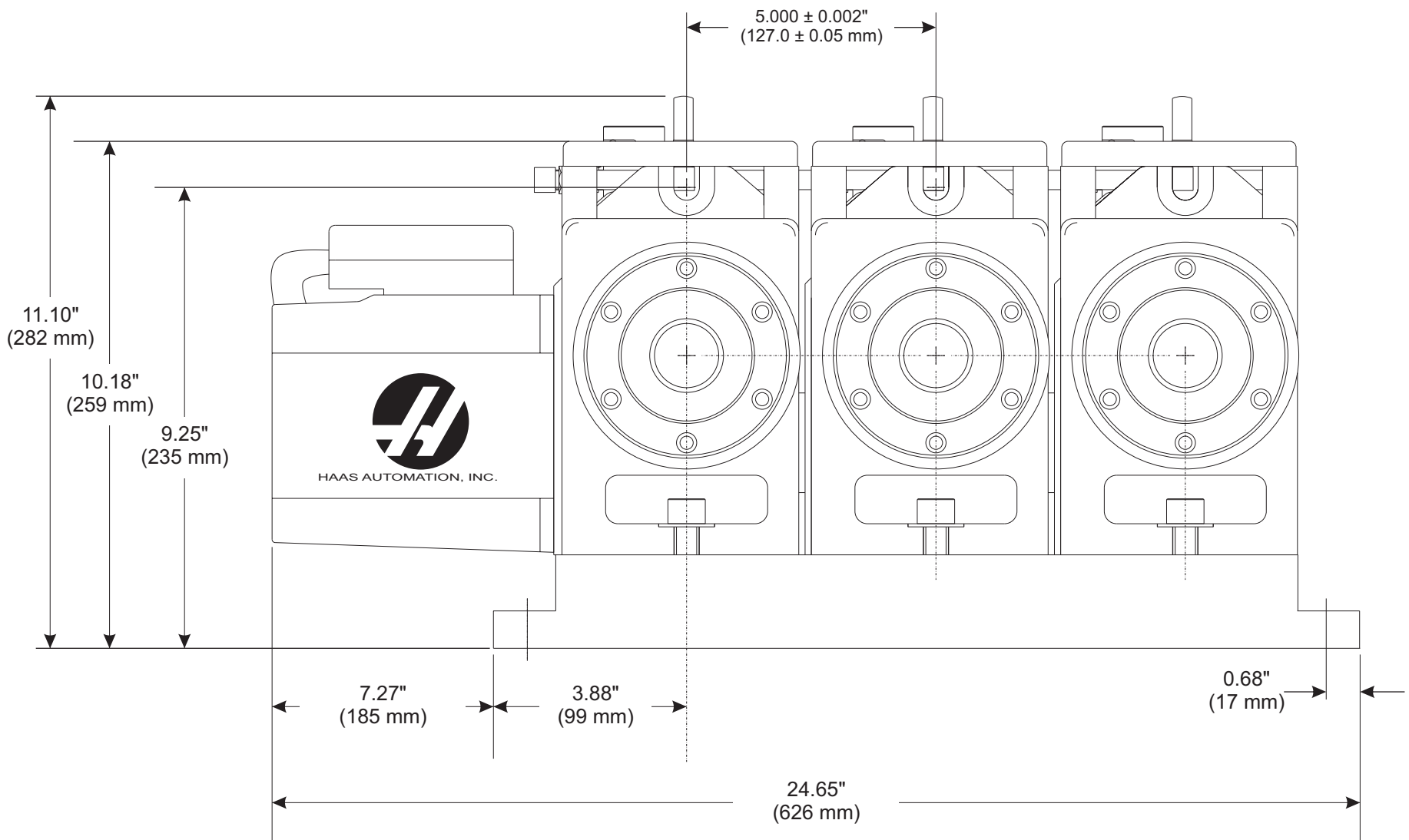

For mounting instructions,
see Rotary Operator's Manual.

Go to www.haascnc.com
for further rotary specifications.